



FILM PRODUCTION RENTALS & SERVICES

"Specializing in Camera Support Equipment, Grip Rigging Rentals, Equipment & Expendable Sales"

LOCALLY-OWNED AND OPERATED IN NEW MEXICO. OUR WAREHOUSE IS LOCATED AT I-25 STUDIOS IN ALBUQUERQUE, NEW MEXICO. WE PROVIDE CHAPMAN-LEONARD STUDIO EQUIPMENT, DOLLY TRACKS AND SLIDERS AS WELL AS GRIP & RIGGING SUPPLIES FOR RENTAL OR SALE TO ALL TYPES OF PRODUCTIONS:

- *Commercials
- *Feature Films
- *Television Shows
- *Documentaries
- *Concerts & Live Performances
- *Commercial & Industrial Installations
- *Sporting Events



For further inquiries, please contact us:

Mailing Address:
Maleko Grip & Rigging
PO Box 27723
Albuquerque, NM 87125
Office: (505) 474.7744 (GRIP.RIG)
Fax: (818)760.5295 Email: sales@malekogrip.com
Website: www.malekogrip.com

Physical Address:
I-25 Studios
c/o Maleko Grip & Rigging
9201 Pan American Freeway NE
Albuquerque, NM 87125



FILM PRODUCTION RENTALS & SERVICES

Camera Support Rentals.....3

 Chapman Leonard Studio Equipment.....3-7

 Dolly Tracks & Sliders.....8-9

Grip & Rigging Rental.....10

Sales.....11-13

Contact Us.....14



CAMERA SUPPORT RENTALS

Maleko Grip & Rigging is the "Exclusive" New Mexico Vendor for **CHAPMAN-LEONARD** Studio Equipment, providing their Full Line of products and additional camera support rentals: **FILMAIR** Dolly Tracks, **MODERN** Camera Sliders

** Please see our "Product Info/Features" link at www.malekogrip.com for additional information of Equipment Features & Specifications**

CAMERA DOLLIES *(Hydraulic Lift Camera Dolly)*

SUPER PEE WEE IV

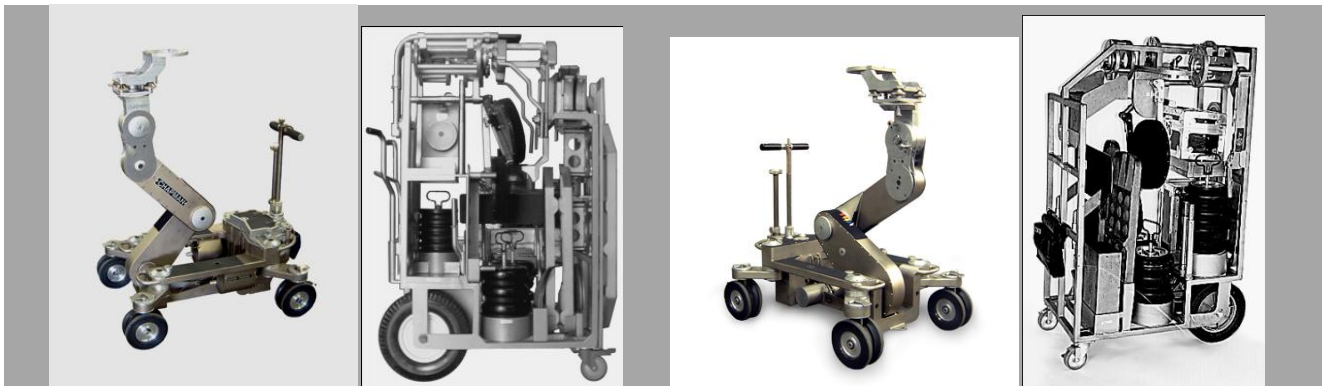

SUPER PEE WEE III PLUS

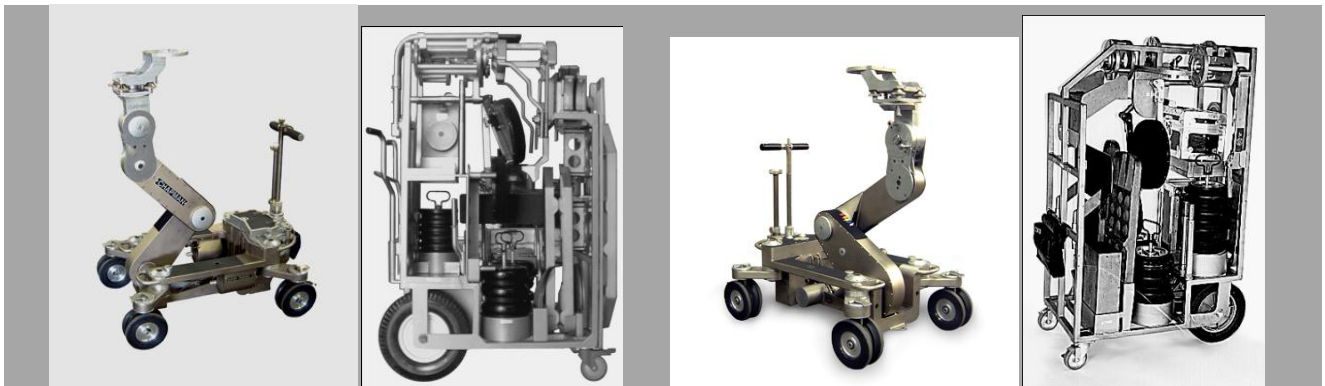

HUSTLER IV



HYBRID III





CAMERA SUPPORT RENTALS

JIBS & LENNY ARMS (For Remote Use)

LENNY MINI

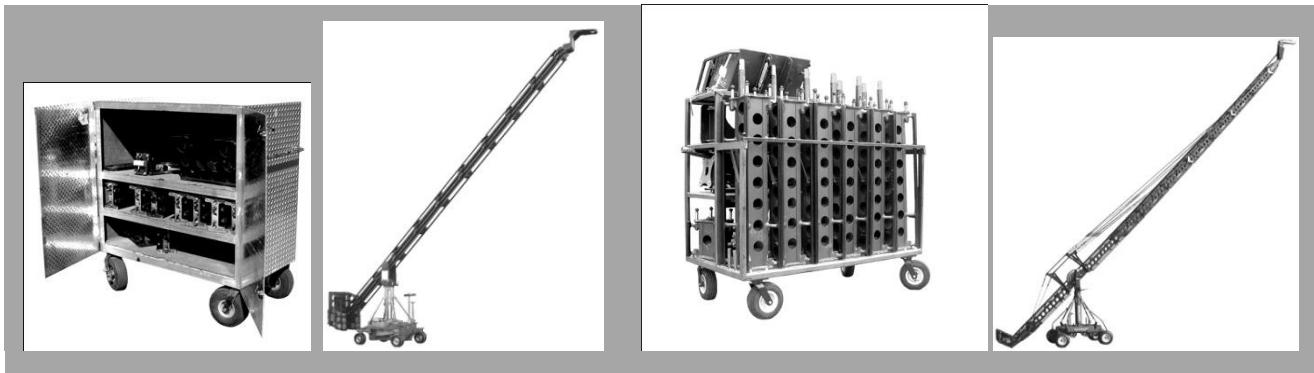

LENNY ARM II PLUS

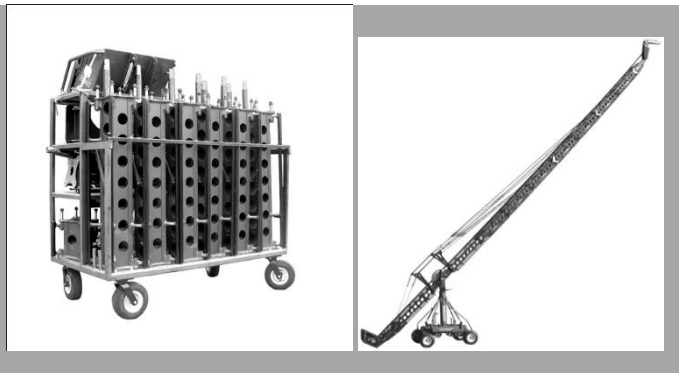

LENNY ARM III: (For Manned or Remote Use)

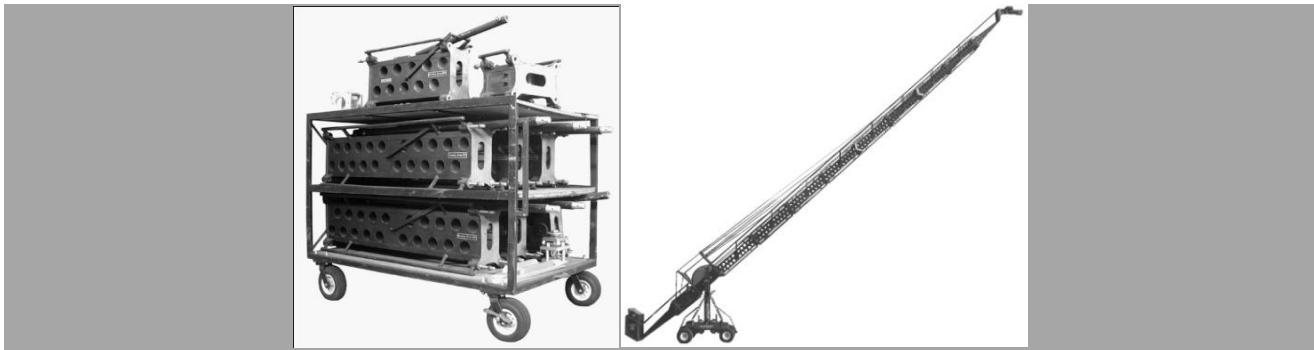

STINGER II JIB ARM: (Jib Arm w/ 24" Glide)





CAMERA SUPPORT RENTALS

CRANE ARMS (*Mobile Crane*)

SUPERNOVA:



TITAN II:



TELESCOPING CRANE

HYDRASCOPE: 15', 20' 32' (*Waterproof Telescoping Crane Arm*)

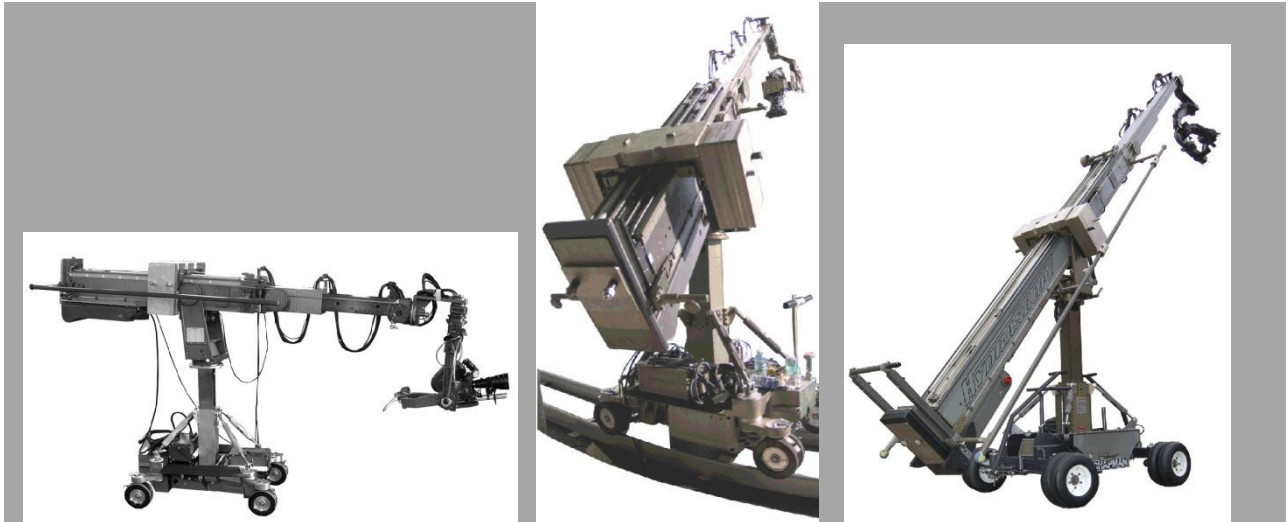



CAMERA SUPPORT RENTALS

BASE (Remote Arm Base)

HY HY BASE:



CS BASE:



RAPTOR: (Mobile Arm Vehicle)

(W/ CHAPMAN-LEONARD AUTO LEVEL SYSTEM)





CAMERA SUPPORT RENTALS

REMOTE HEADS

G-2 GYRO STABILIZED HEAD



(2-Axis Head w/ Preston)

G-3 GYRO STABILIZED HEAD



(3-Axis Head w/ Preston)

VIBRATION ISOLATION SYSTEM (Stabilizing System)

VIBRATION ISOLATOR- HORIZONTAL

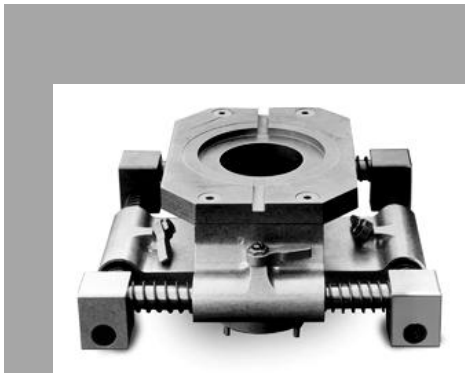

GIMBAL



VERTICAL VIBRATION ISOLATOR-LARGE



Vertical VI Large w/ Horizontal VI



Vertical VI Large w/ Gimbal



DOLLY TRACKS & SLIDERS

FILMAIR: DOLLY TRACKS: (STRAIGHT)

Hi-load Aluminum 24-1/2" Dolly Track (*American Standard Profile*)

SPECIFICATIONS AND DIMENSIONS:

Standard. Lengths Weight Length When Folded

2 ft. (607 mm) 8.5 lbs. (3.9 kg) Fixed
4 ft. (1219 mm) 13.5 lbs. (6.1 kg) 6 ft. (1829 mm)
6 ft. (1829 mm) 19.5 lbs. (8.9 kg) 8 ft. (2439 mm)
8 ft. (2439 mm) 23 lbs. (10.6 kg) 10 ft. (3048 mm)
10 ft. (3048 mm) 28.5 lbs. (13 kg) 12 ft. (3658 mm)



FILMAIR: DOLLY TRACKS: (CURVED)

45 Degree Curved 24-1/2" Dolly Track (*American Standard Profile*)

SPECIFICATIONS AND DIMENSIONS:

Overall Length Width Weight

91.2" (2316 mm) 32.4" (823 mm) 22.5 lbs. (10 kg)



90 Degree Curved 24-1/2" Dolly Track (*American Standard Profile*)

SPECIFICATIONS AND DIMENSIONS:

Overall Length Width Weight

119" (3018 mm) 43.2" (1097 mm) 29.5 lbs. (13.5 kg)

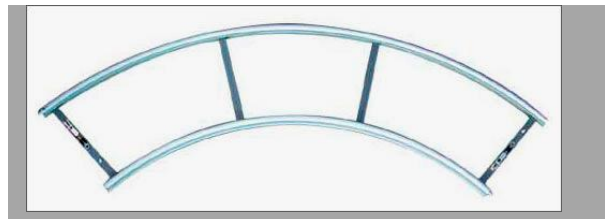

Starter Ramp for 24" Dolly Track (*American Standard Profile*)

SPECIFICATIONS AND DIMENSIONS:

Overall Length Width Weight

27.6" (701 mm) 26.4" (671 mm) 6.5 lbs. (3 kg)

(Add-On Support Accessories Available)

****DOLLY WEDGES, CRIBBING, BASSO BLOCKS
& LOCK BLOCKS****





DOLLY TRACKS & SLIDERS

MODERN: CAMERA SLIDERS (w/ 360 Degree Swivel Option)

2 FT CAMERA SLIDER

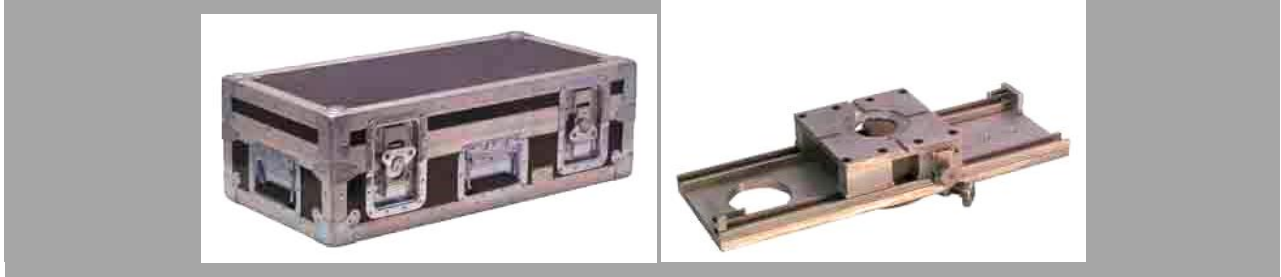

3 FT CAMERA SLIDER



4 FT CAMERA SLIDER





GRIP & RIGGING RENTALS

COMPLETE GRIP & RIGGING RENTALS

- * ALUMINUM TRUSS
- * GRID & TRUSS INSTALL
- * CHAIN MOTOR/ CHAIN HOIST / BLOCK & FALLS
- * CURTAIN TRACK / CURTAIN TRUSS
- * ALUMINUM I-BEAM
- * I-BEAM TROLLEYS
- * STAGING (STEEL DECK)
- * TECHNICAL FABRICS & BACKINGS
- * FALL PROTECTION SYSTEMS & FALL ARREST EQUIPMENT
 - Full Body Harnesses
 - Self-Retracting Lifelines
 - Horizontal Lifelines
 - Vertical Lifelines
 - High Angle Rescue
 - Fall Arrest Gear
 - Carabiners
 - Spansets, Wire Rope, Fiber-Tech & Webbing
- * MODERN BAZOOKA COMPLETE
- * SKATEBOARD DOLLY SLEDS
- * MODERN- CAR MOUNTS
 - Hostess Tray w/ 90 Degree Tilt Plate
 - Hood Mount w/ 2 Dish Leveling Head
- * SAND/SHOT BAG
- * FABRIC EGG CRATES
- * HD TENTS
- * WIND FABRICS
- * HEAT FABRICS
- * DRAPES & CURTAINS
- * NETS
- * REFLECTIVES
- * BLUE/GREEN SCREENS
- * GELFAB
- * DIFFUSIONS

- * 2008 YAMAHA RHINO SIDE BY SIDE
 - (4x4 ATV w/ Fuel Injection & Disc Brakes)
 - (Dual Axle Trailer w/ Flip Gate)
- * 5 TON (FL70) - GRIP TRUCK PACKAGE
- * INDIVIDUAL GRIP/RIG

COMPLETE RIGGING INSTALLATION

- * PIPE GRID & TRUSS INSTALLATION
- * TEMPORARY & PERMANENT FALL ARREST SYSTEM
- * HEAVY EQUIPMENT & MATERIAL HANDLING
- * AUDITORIUM & EVENT VENUE RIGGING
- * PERFORMING ARTS INSTALLATION



SALES

***EXPENDABLE PRODUCTS**

*AIRCRAFT CABLES:

- Galvanized, Black Powder
- Sizes: 1/16", 3/32", 1/8"
3/16", 1/4", 3/8", 1/2"

* COPPER SLEEVES

- Galvanized, Black Powder
- Sizes: 1/16", 3/32", 1/8"
3/16", 1/4", 3/8", 1/2"

* THIMBLES

- Galvanized, Black
- Sizes: 1/16", 1/8", 3/16"
1/4", 3/8", 1/2"

* TURNBUCKLES

- Hook & Eye, Eye & Eye, Jaw & Jaw
- Sizes: 1/4", 5/16", 3/8", 1/2"

* RATCHET STRAP w/ WIRE HOOK

- Sizes: 2"x 30', 2"x 27'

* RATCHET STRAP w/ "S" HOOK

- Size: 1"x15'

* ENDLESS WRAP STRAP

- Sizes: 1"x 20', 2"x 30', 1"x 30'

* SAFETY CABLE

- Black Lighting, Galvanized
- Size: 1/8"x 30"

* SASH CHAIN

- Copper #40 & Zinc #35

* FURNITURE PADS

- Blue or Black, Camouflage
- Size: 72" X 80"

* VELCRO (Misc Sizes)

- Hook & Loop

* MILK CRATES

- Full & Half

* SHACKLES

- SPA, Black SPA
- Sizes: 3/16", 1/4", 5/16"
3/8", 1/2", 5/8"

* MACHINERY EYEBOLTS

- Sizes: #21, #22, #23, #25

* EYENUT

- Sizes: 1/4-20, 5/16-18, 3/8-16
1/2-13

* PAD EYE

- Sizes: #1, #1-1/2, #2, #4, #5

* RITE LOCKS w/EYENUT

- Sizes: 1/16", 1/8"

* TIE-OFF (E-TRACK D-RING)

- Size: 2"x 6"

* PETZL PITON

- Sizes: 5cm, 7cm, 9cm

* ROPE RATCHET

- Sizes: 1/4", 3/8"

* BOLT HANGERS (ROCK-JOX)

- Sizes: 10mm & 12mm

*SPEED CLIPS

- White & Black
- Sizes: 1 1/4", 1 1/2"

* GRIP CLIPS

- Sizes: #1, #2 & #3

* BURLAP

- Size: 20" x 36"

* CARABINERS

- Multiple Options



SALES

******STAGING HARDWARE******

- * **WEBBING & RUNNERS**
 - Sizes: 4", 6", 12", 18"
24", 36", 48"
- * **PIPE CLAMPS w/TAB**
 - Sizes: 1-1/4", 1-1/2"
- * **CHEZBURO**
 - Steel Fixed, Steel Swivel
- * **GRAV-LOCKS (Beam to Pipe Clamp)**
 - Steel Fixed, Steel Swivel
- * **PROBURGERS (Aluminum Pipe Clamp)**
 - Swivel, 1/2"w/3/8" Bolt
 - Grid Clamps: Baby, Junior ,w/ Eye
- * **BEAM CLAMP**
 - Sizes: 1 Ton, 2 Ton
- * **CENTER LOAD BEAM CLAMPS**
 - Fixed: 3", 4", 6" & 7"
 - Adjustable: 3"-7"
- * **SPEEDRAIL FITTINGS (Pre-Order)**
 - Sizes: 1", 1 1/4" & 1 1/2"
- * **FLOOR PLATE & D-RINGS**
 - For Backing Track & Tie Down
- * **DAISY CHAINS**
 - Multiple Options
- * **SLEEVE COUPLER**
 - Sizes: 1-1/4", 1-1/2"
- * **STUDIO CHAIN**
 - Sizes: 6/0
- * **SWIVEL EYE PULLEY**
 - Sizes: 2-1/2", 3"
2" (Awning)
- * **SPLIT SHEAVE PULLEY**
 - Size: 2-3/8" (RP102)
- * **QUICK LINKS**
 - Sizes: 1/4", 5/16" , 3/8"
- * **SPRING LINK w/ & w/o THIMBLE**
 - Sizes: 1/4", 5/16"

******CUSTOM ORDERS AND FABRICATION SERVICES AVAILABLE******

******ROPE******

(INDUSTRY LENGTHS & SIZES AVAILABLE)

- * **MANILA**
- * **MULTILINE**(White/Blk /DigiBlue&Green)
- * **STATIC**
- * **DYNAMIC**
- * **SPECTRA /TECHNORA / KEVLAR**
- * **SASH CORD**
- * **MASON**
- * **TRICK LINE**
- * **BUNGEE CORD**

******SLINGS******

- * **WIRE ROPE**
- * **SPANSETS**
- * **FIBER TECH (FIREPROOF)**
- * **NYLON**
- * **CHAIN**
- * **SPECIAL ASSEMBLY**



SALES

******TOOLS AND CUTTERS******

- * SWAGE TOOLS
- * FELCO CUTTERS
- * BOLT CUTTERS
- * HOT KNIFE - ROPE CUTTER

******FALL ARREST AND SAFETY EQUIPMENT******

- * FULL BODY HARNESSSES
- * ROPE GRABS
- * MISC PROTECTIVE GEAR
- * YO-YOs / SELF RETRACTING LIFELINES
- * HORIZONTAL & VERTICAL LIFELINES
- * ANCHOR STRAPS, BEAM CLAMPS, ANCHOR TROLLEYS
- * LADDER SAFETY SYSTEMS
- * LANYARDS
- * HIGH ANGLE RESCUE

******TECHNICAL FABRICS & BACKINGS******

- * BLUE & GREEN SCREENS
- * BLUE & GREEN SCREEN TAPE
- * SOLIDS & BACKINGS
- * REFLECTIVES
- * FABRIC EGG CRATES
- * HEAT FABRICS
- * GEL FAB
- * DIFFUSIONS
- * BOUNCES
- * NETS
- * WIND FABRICS
- * DRAPES & CURTAINS



CONTACT US

MARK STEINIG

***Chapman-Leonard Representative (New Mexico)**

***Key Rigging Grip**

Cell: 505.872.4747

Email: mark@malekogrip.com

JADE STEINIG

*** VP Marketing & Accounts**

Office: 505.474.7744(GRIP.RIG)

Product Inquiry: sales@malekogrip.com

MAILING ADDRESS:

PO Box 27723

Albuquerque, NM 87125

PHYSICAL ADDRESS:

I-25 Studios

9201 Pan American Freeway Dr. NE

Albuquerque, NM 87113

Office: 505.474.7744(GRIP.RIG) (Please call office for appointment)